



**Magnetic Torpedo Laser Level**  
**Model No. 40-6164**



# Instruction Manual

*Congratulations on your choice of this Magnetic Torpedo Laser Level. We suggest you read this instruction manual thoroughly before using the instrument. Save this instruction manual for future use.*

This tool emits one laser beam that is selectable as a point, vertical line, or horizontal line. Visibility of the beam depends upon lighting conditions in the work area.

This is a Class IIIa laser tool and is manufactured to comply with CFR 21, parts 1040.10 and 1040.11 as well as international safety rule IEC 285.



## Table of Contents

- |  |                                  |
|--|----------------------------------|
| 1. Kit Contents                          | 8. Self-Check & Fine Calibration |
| 2. Features and Functions                | 9. Technical Specifications      |
| 3. Safety Instructions                   | 10. Application Demonstrations   |
| 4. Location/Content<br>of Warning Labels | 11. Care and Handling            |
| 5. Location of Parts/Components          | 12. Product Warranty             |
| 6. Operating Instructions                | 13. Warranty Registration        |
| 7. Using the Product                     | 14. Accessories                  |
|  | 15. Trouble Shooting             |

## 1. Kit Contents

### Model No. 40-6164

	<u>Qty.</u>
Magnetic Torpedo Laser Level	1
“AAA” Alkaline Batteries	2
Instruction Manual with Warranty Card	1
Soft-sided Pouch	1

## 2. Features and Functions

- Aluminum frame for superior accuracy and durability
- Four vials read plumb, level, 45° and cross check
- Built-in rotating head swivels to project laser dot, horizontal or vertical line
- Magnetic bottom allows unit to be attached to metal
- Available for operation by mounting on tripod





### 3. Safety Instructions

Please read and understand all of the following instructions, prior to using this tool. Failure to do so, may void the warranty.

#### **DANGER!**

Class IIIa Laser Product  
Max. Power Output:  $\leq 5\text{mW}$   
Wavelength: 640-660nm

**THIS TOOL EMITS LASER RADIATION.  
DO NOT STARE INTO BEAM.  
AVOID DIRECT EYE EXPOSURE.**



#### **ATTENTION**



#### **IMPORTANT**

- Read all instructions prior to operating this laser tool. Do not remove any labels from tool.
- Do not stare directly at the laser beam.
- Do not project the laser beam directly into the eyes of others.
- Do not set up laser tool at eye level or operate the tool near a reflective surface as the laser beam could be projected into your eyes or into the eyes of others.
- Do not place the laser tool in a manner that may cause someone to unintentionally look into the laser beam. Serious eye injury may result.
- Do not operate the tool in explosive environments, i.e. in the presence of gases or flammable liquids.
- Keep the laser tool out of the reach of children and other untrained persons.
- Do not attempt to view the laser beam through optical tools such as telescopes as serious eye injury may result.
- Always turn the laser tool off when not in use or left unattended for a period of time.
- Remove the batteries when storing the tool for an extended time (more than 3 months) to avoid damage to the tool should the batteries deteriorate.
- Do not attempt to repair or disassemble the laser tool. If unqualified persons attempt to repair this tool, warranty will be void.
- Use only original Johnson® parts and accessories purchased from your Johnson® authorized dealer. Use of non-Johnson® parts and accessories will void warranty.





## 4. Location/Content of Warning Labels



Mfg. for Johnson Level & Tool Mfg. Co., Inc.  
6333 W. Donges Bay Rd., Mequon, WI 53092  
Manufactured in China by JLT05  
Date (m/y): \_\_\_\_\_

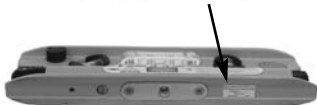



## 5. Location of Part/Components

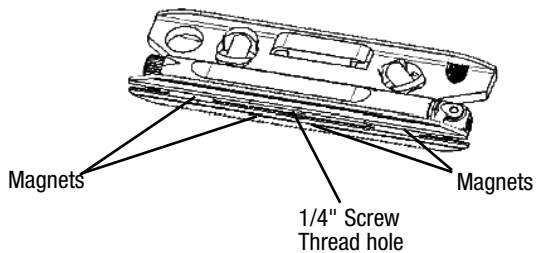
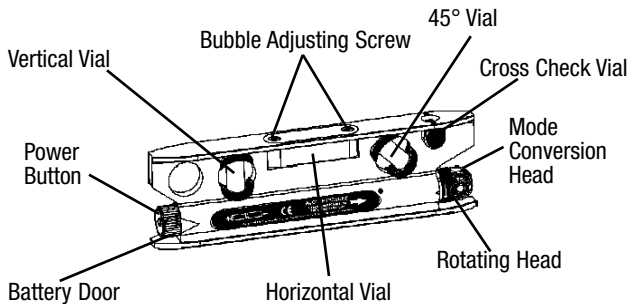

## 6. Operating Instructions

**IMPORTANT:** It is the responsibility of the user to verify the calibration of the instrument before each use.

### Battery Installation

Remove battery door by rotating it counter-clockwise, put in two alkaline “AAA” batteries according to the illustrated polarity requirements, then install the battery door by rotating it clockwise.

**Note:** Used (discharged) batteries are hazardous waste and should be disposed of properly.

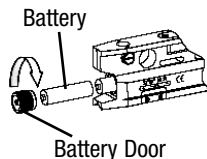

## 7. Using the Product

### Power On/Off

1. Press power switch to project laser line or point.
2. Press power switch again to shut off laser output.

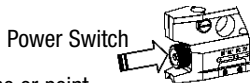

### Switch Between Laser Point and Laser Line

1. Turn the mode conversion knob to switch between laser line and laser point. Rotating the lens up or down converts laser from a dot to a line, or line to a dot. Rotating the lens counter-clockwise, while in line mode, rotates line from horizontal to vertical.

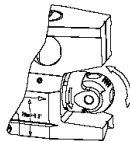

Rotate to switch between point and line



**Note:** The rotating head can be turned only in the direction indicated by arrowhead sign.

### Rotatable Line Status

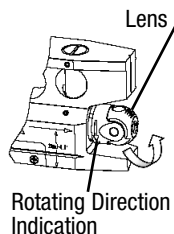

## 8. Self-Check & Fine Calibration

**IMPORTANT:** It is the responsibility of the user to verify the calibration of the instrument before each use.

### Checking Vials

Start by making sure that the vials are accurate. This is done by placing the level on a flat surface and noting the position of the vial. Rotate the level by 180 degrees (on the same gauging edge) and observe that the bubble is in the same position.





## Calibrating Vials

To access the calibration screws remove the stickers located to the right and left of the vial at the top of the unit. First, adjust the calibration screws to move the bubble back to center taking out half of the error in the vial. Rotate the level 180° on the same gauging edge and move the bubble to center. Repeat this process until the error is entirely removed and the bubble stays in the center. Plumb vial, cross check vial and 45° vial cannot be calibrated.

## Checking Laser

Once the vials are accurate, laser accuracy can be verified (near target, far target method). Start by placing the unit on a flat surface and aim the laser at a stationary target. Position the unit/target at close range and note a reference point on the target. As the unit is moved away from the target, such that alignment of the laser to the target is fixed, and the only variable is distance, the accuracy of the laser can be verified/calibrated.

## Calibrating Laser

There are set screws on the side and bottom of the unit that provide calibration for the laser. One screw will need to be loosened before the opposite screw can be tightened.

For vertical calibration, use underside screws, tightening the front screw to adjust up and tighten the rear to adjust down.

For horizontal calibration, use two screws on either side of the unit. Tighten the right screw to adjust right. Tighten the left screw to adjust left.







## 9. Technical Specifications

Laser Wavelength	650nm $\pm$ 10
Laser Classification	Class IIIa
Maximum Power Output	$\leq$ 5mW
Accuracy	$\pm$ 1/8"/50 ft. ( $\pm$ 1mm/5m)
Interior Range	Up to 100 ft. (30m) depending upon light conditions
Power Supply	2 "AAA" alkaline batteries
Battery Life	Approx. 30 hours continuous use
Dimensions	7-1/2" x 2-1/8" x 3/4" (190 x 55 x 20mm)
Weight	0.7 lbs. (0.3 Kg)
Working Temperature	14°F to 113°F (-10°C to +45°C)
Center Screw Thread	1/4" – 20





## 10. Application Demonstrations

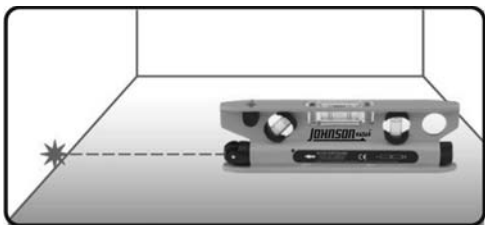

Projects one laser point

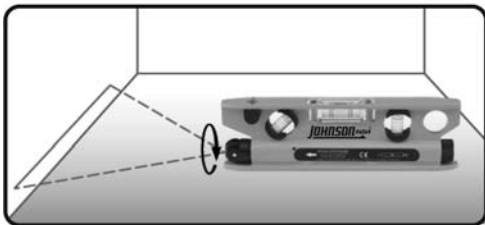

Projects one horizontal laser line

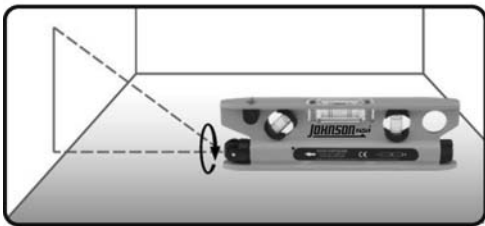

Projects one vertical laser line





## 11. Care and Handling

- This laser unit is a precision tool that must be handled with care.
- Avoid exposing unit to shock vibrations and extreme temperatures.
- Before moving or transporting the unit, make sure that the unit is turned off.
- Remove the batteries when storing the unit for an extended time (more than three months) to avoid damage to the unit should the batteries deteriorate.
- Always store the unit in its case when not in use.
- Avoid getting the unit wet.
- Keep the laser unit dry and clean, especially the laser output window. Remove any moisture or dirt with a soft, dry cloth.
- Do not use harsh chemicals, strong detergents or cleaning solvents to clean the laser unit.

## 12. Product Warranty

Johnson Level & Tool offers a three year limited warranty on each of its products. You can obtain a copy of the limited warranty for a Johnson Level & Tool product by contacting Johnson Level & Tool's Customer Service Department, as provided below, or by visiting our web site at [www.johnsonlevel.com](http://www.johnsonlevel.com). The limited warranty for each product contains various limitations and exclusions.

Do not return this product to the store/retailer or place of purchase. Non-warranty repairs and course calibration must be done by an authorized Johnson® service center or Johnson Level & Tool's limited warranty, if applicable, will be void and there will be NO WARRANTY. Contact one of our service centers for all non-warranty repairs. A list of service centers can be found on our web site at [www.johnsonlevel.com](http://www.johnsonlevel.com) or by calling our Customer Service Department. Contact our Customer Service Department for Return Material Authorization (RMA) for warranty repairs (manufacturing defects only). Proof of purchase is required.





**NOTE:** The user is responsible for the proper use and care of the product. It is the responsibility of the user to verify the calibration of the instrument before each use.

For further assistance, or if you experience problems with this product that are not addressed in this instruction manual, please contact our Customer Service Dept.

In the U.S., contact Johnson Level & Tool's Customer Service Department at 888-9-LEVELS.

In Canada, contact Johnson Level & Tool's Customer Service Department at 800-346-6682.

### 13. Warranty Registration

Enclosed with this instruction manual you will find a warranty registration card to be completed for your product. You will need to locate the serial number for your product that is located at the side of the torpedo level. **PLEASE NOTE THAT IN ADDITION TO ANY OTHER LIMITATIONS OR CONDITIONS OF JOHNSON LEVEL & TOOL'S LIMITED WARRANTY, JOHNSON LEVEL & TOOL MUST HAVE RECEIVED YOUR PROPERLY COMPLETED WARRANTY CARD AND PROOF OF PURCHASE WITHIN 30 DAYS OF YOUR PURCHASE OF THE PRODUCT OR ANY LIMITED WARRANTY THAT MAY APPLY SHALL NOT APPLY AND THERE SHALL BE NO WARRANTY.**





## 14. Accessories

Johnson® accessories are available for purchase through authorized Johnson® dealers. Use of non-Johnson® accessories will void any applicable limited warranty and there will be NO WARRANTY. If you need any assistance in locating any accessories, please contact our Customer Service Department.

In the U.S., contact Johnson Level & Tool's Customer Service Department at 888-9-LEVELS.

In Canada, contact Johnson Level & Tool's Customer Service Department at 800-346-6682.

## 15. Trouble Shooting

- If the laser does not illuminate, check the battery polarity or clean battery terminals and install new alkaline batteries. If the power is intermittent, the on/off switch may need to be replaced.
- If the unit does not turn on, check the battery polarity or install new alkaline batteries and clean the battery terminals. If the power is intermittent, the on/off switch may need to be replaced.
- If the unit turns off after a short time, install new alkaline batteries and clean the battery terminals. If the power is intermittent, the on/off switch may need to be replaced.
- If the unit will not calibrate, contact an authorized Johnson service center or Johnson Level & Tool's Customer Service Department.
- If the unit is out of calibration, follow calibration procedure in manual.



